

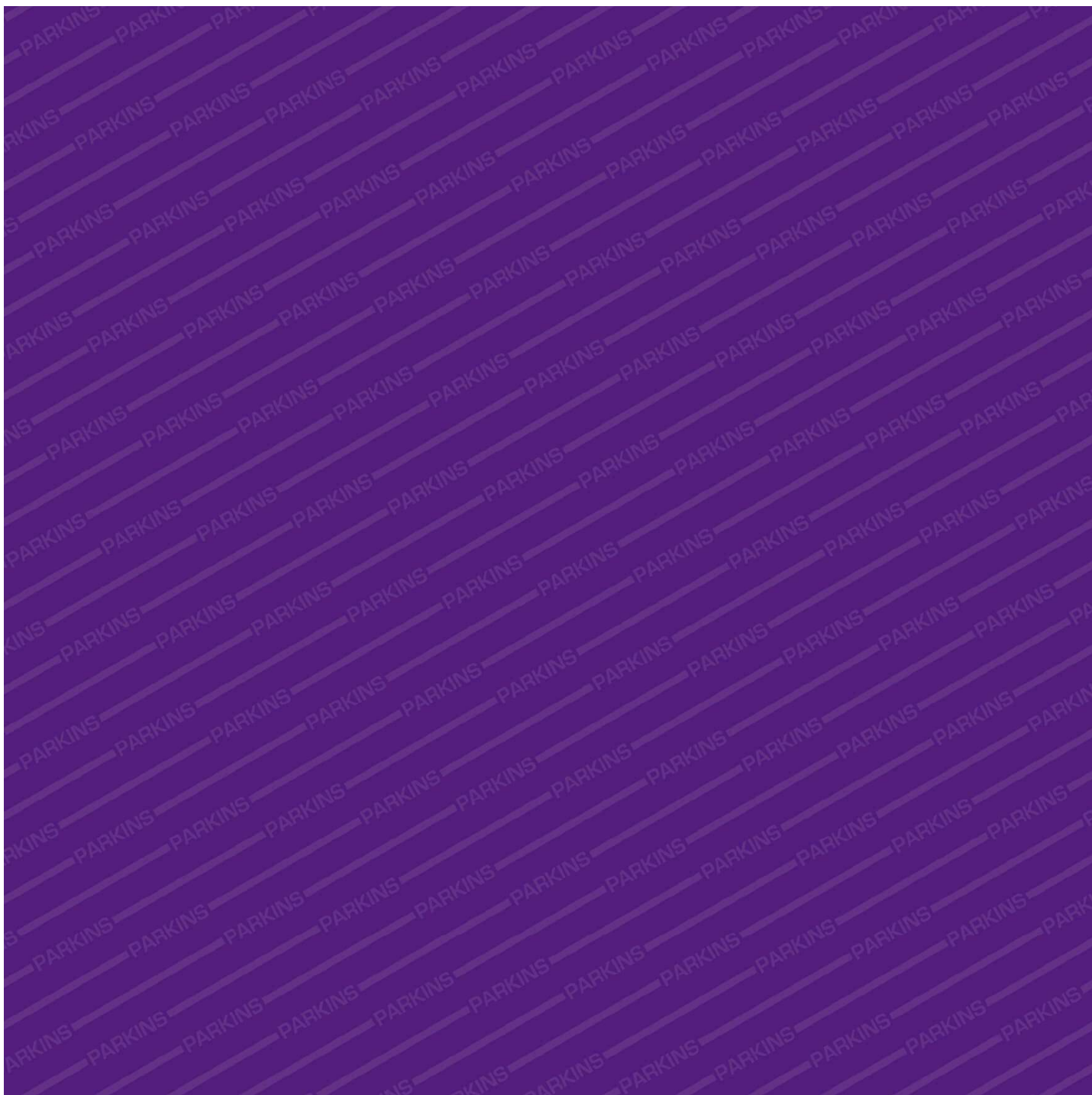

Perforated Bag

**PARKINS**  
PLASTIC MACHINERY CO.,LTD



# PERFORATED BAG CATALOGUE

COMPANY PROFILE	02
BJAH2+S	05
BJAH+C2S	06
BJAHC1+ST	07
BJAHCL+CF	08
BJAHCL2+ST	09
BJAHPCL2+STL	10
BJAHCD	11
OPTION	12

# COMPANY PROFILE

COMPANY PROFILE

02

PARKINS PLASTIC MACHINERY CO., LTD.

PARKINS PLASTIC MACHINERY CO., LTD. was established in 1976 under the leadership of President C.I. Lin. PARKINS has successfully developed the most comprehensive range of plastic bag sealing and cutting machines with 40 years of experiences and that makes it to be rewarded as one of the leading manufacturers in Taiwan plastic machinery industry. PARKINS' machines have been sold in over 60 countries, and received full approval from customers over the world.

Based on PARKINS' the advanced bag making concepts, we are equipped with high-quality spare parts, and advanced devices to increase product functionality; at the same time maintaining the stability and quality during bag making process. We adopt modern production management, and all parts are precision machined by sophisticated CNC equipment to ensure machine accuracy and parts interchangeability.

"PARKINS" written in Chinese as "BAI-JIU" implicates "Everlasting Century". We will uphold our principle of sustainability and keep striving for more enhanced machines and superior technical services for our valuable customers.

We manufacture a variety of bag making machines. Products including High-Speed T-shirt Bag, Perforating Bag-on-roll Garbage Bag, Bottom-Sealing Bag, Heavy-Duty Bag, Laundry-Bag, Side-Sealing Bag, Calendar Bag, EVA or PE material deposable Gloves, and etc..

Kindly refer to our website: [www.parkins.com.tw](http://www.parkins.com.tw) for more information. Please do not hesitate to email or call us for any further questions or inquiries. We will provide our most competitive quotations and delivery time to meet your requirements and needs. We believe that you will discover the machine that surpasses your needs.

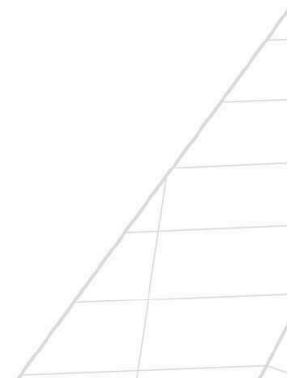

23.5°N Tropic of Cancer Solar Exploration Center

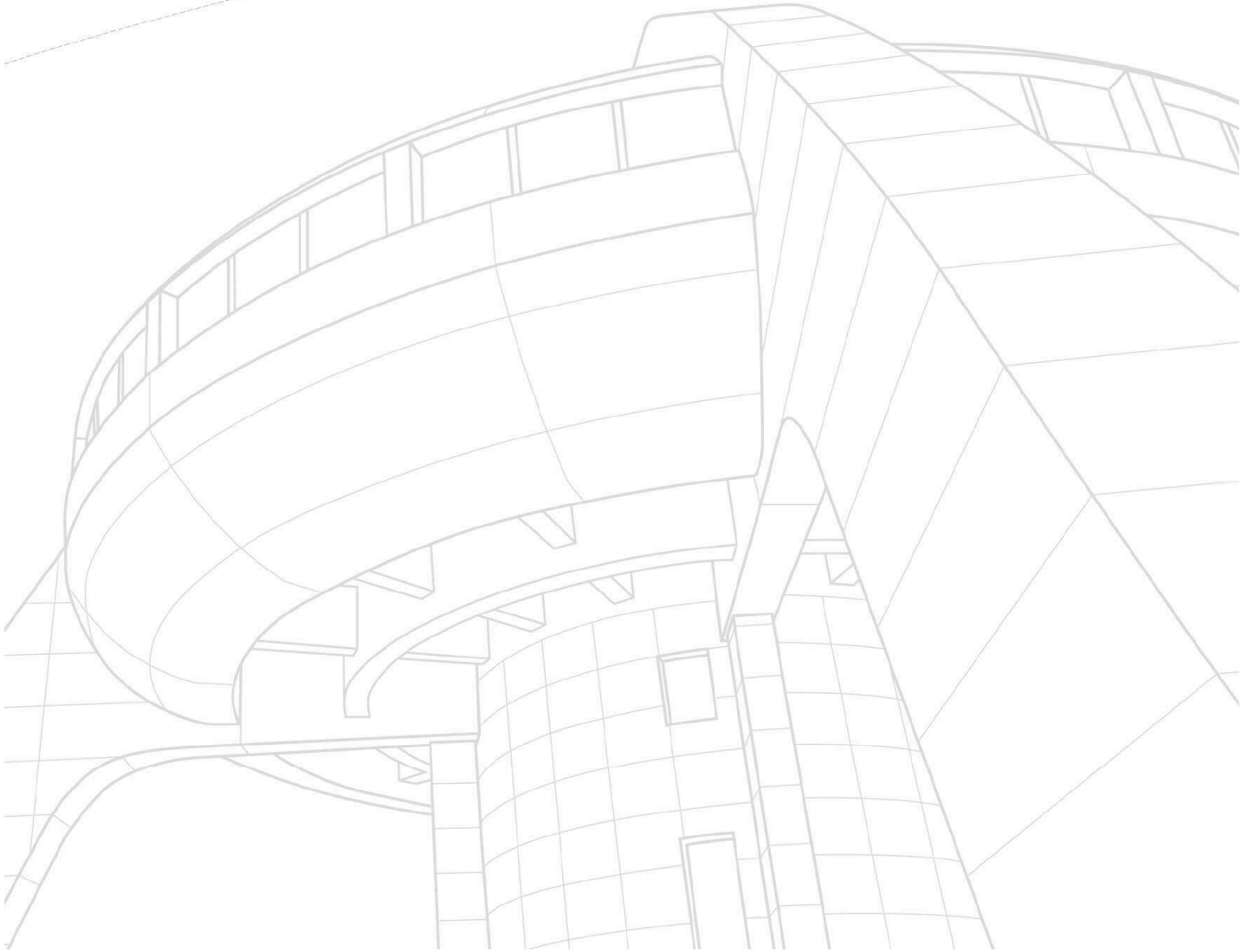



PRODUCTS

04

PARKINS PLASTIC MACHINERY CO., LTD.

# PARKINS PLASTIC MACHINERY

[www.parkins.com.tw](http://www.parkins.com.tw)

# BJAH2+S

Double-Lane Core & Coreless  
Perforating Bag- on-Roll Machine

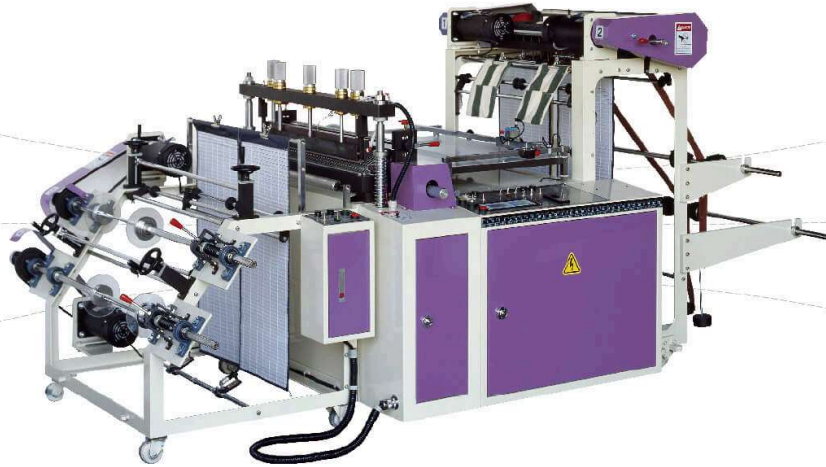

## FEATURES >>

- Uses servo motor for feeding, with stable sealing abilities, and fast on speed change  
Easy to change bag size, and size error is permissible.
- Available for production of either two small lines or one big line of bag-on-roll products.

## SPECIFICATIONS >>

MODEL	BJAH1+S 20"x 30"	BJAH1+S 28"x 42"	BJAH2+S 28"x 42"	BJAH2+S 32"x 48"
Max. Cutting Width mm (inch)	457 ( 18")	660 ( 26")	660 ( 26") or 304 ( 12") x 2	762 ( 30") or 355 ( 14") x 2
Max. Cutting Length mm (inch)	762 ( 30")	1066 ( 42")	1066 ( 42")	1219 ( 48")
Thickness (micron / sheet)	9 - 40	9 - 40	9 - 40	9 - 40
Length Tolerance (mm)	±1	±1	±1	±1
Production Rate (pcs / min)	max.150	max.150	max.150	max.150
AC Driving Motor (HP)	1	2	2	2
Heater Capacity (kW)	1.5	2.2	2.2	2.8
Power Required (kW)	5.5	7	8	8.6
Main Machine Dimensions (L*W*H cm)	310 x 105 x 140	345 x 125 x 140	310 x 105 x 140	345 x 135 x 146
Machine Weight (kg)	650	800	800	950
Packing Measurement (L*W*H cm)	260 x 133 x 176	273 x 146 x 176	273 x 146 x 176	273 x 156 x 176
Gross Weight (kg)	800	1100	1150	1200

Correct specifications depend on the actual model. All specifications are subject to change without prior notice.

# BJAH+C2S

Double-Lane with Core Fully Automatic Servo-Control  
Perforating Bag-on-Roll Machine



BJAH+C2S

06

PARKINS PLASTIC MACHINERY CO., LTD.

## FEATURES >>

- Uses servo motor for feeding, with stable sealing abilities, and fast on speed change. Easy to change bag size, and size error is permissible.
- Fully automatic double-lane roll changing and winding device.

## SPECIFICATIONS >>

MODEL	BJAH+C2S 28"x 30"	BJAH+C2S 32"x 30"	BJAH+C2S 40"x 30"
Max. Cutting Width mm (inch)	254 ( 10") x 2	304 ( 12") x 2	406 ( 16") x 2
Max. Cutting Length mm (inch)	762 ( 30")	762 ( 30")	762 ( 30")
Thickness (micron / sheet)	9 - 40	9 - 40	9 - 40
Length Tolerance (mm)	±1	±1	±1
Production Rate (pcs / min)	max.140	max.140	max.140
AC Driving Motor (HP)	2	2	2
Heater Capacity (kW)	2.2	2.8	3
Power Required (kW)	14.8	15.4	15.6
Machine Dimensions Main (L*W*H cm)	255 x 145 x 165	255 x 155 x 165	255 x 175 x 165
Winding (L*W*H cm)	250 x 206 x 195	250 x 206 x 195	250 x 206 x 195
Machine Weight (kg)	2700	2900	3300
Packing Measurement Main (L*W*H cm)	270 x 160 x 185	270 x 170 x 185	270 x 192 x 185
Winding (L*W*H cm)	264 x 221 x 215	264 x 221 x 215	264 x 221 x 215
Gross Weight (kg)	3200	3500	4050

Correct specifications depend on the actual model. All specifications are subject to change without prior notice.

# BJAHC1+ST

Single-Lane with Core 'Star' Folding Fully Automatic  
Servo-Control Perforating Bag-on- Roll Machine

## SPECIFICATIONS >>

MODEL	BJAHC1 +ST 2030
Max. Cutting Width mm (inch)	406 ( 16")
Max. Cutting Length mm (inch)	762 ( 30")
Thickness (micron / sheet)	80
Length Tolerance (mm)	±1
Production Rate (pcs / min)	max 140
AC Driving Motor (HP)	2
Heater Capacity (kW)	2.7
Power Required (kW)	11.7
Machine Dimensions (L*W*H cm)	800 x 130 x 200
Machine Weight (kg)	2400

Correct specifications depend on the actual model. All specifications are subject to change without prior notice.

## FEATURES >>

- Uses servo motor for feeding, with stable sealing abilities, and fast on speed change. Easy to change bag size, and size error is permissible.
- This machine is specialized for manufacturing perforated bag-on-roll products with paper core. Available for regular perforated bag & star sealing bag.

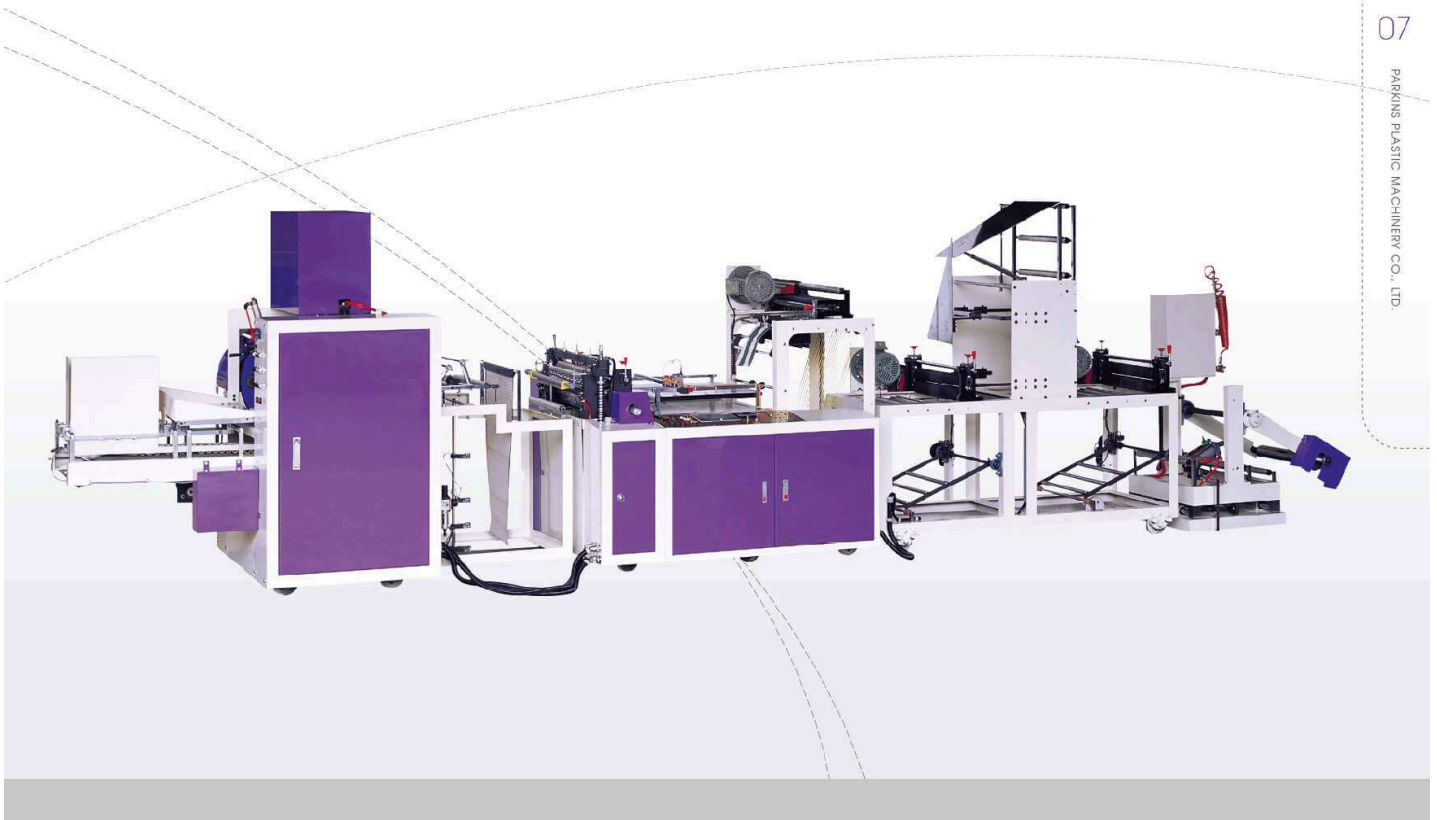

BJAHC1+ST

07

PARKINS PLASTIC MACHINERY CO., LTD.

# BJAHCL+CF | Single-Double Coreless 'C' Folding Perforating Bag-on-Roll Machine



BJAHCL+CF 08 PARKINS PLASTIC MACHINERY CO., LTD.

## SPECIFICATIONS >>

MODEL	BJAHCL +CF 3248
Max. Cutting Width mm (inch)	762 ( 30") x 1 or 279 ( 11") x 2
Max. Cutting Length mm (inch)	1219 ( 48")
Thickness (micron / sheet)	10 - 80
Length Tolerance (mm)	±1
Production Rate (pcs / min)	max. 140
AC Driving Motor (HP)	2
Heater Capacity (kW)	4
Power Required (kW)	15.8
Main Machine Dimensions (L*W*H cm)	860 x 230 x 185
Machine Weight (kg)	3000
C-Folding Width mm (inch)	762 ( 30")
Max Width of Finishe Single Line mm (inch)	330 - 584 (13" - 23")
Double Line mm (inch)	101 - 279 ( 4"-11") x 2
Packing Measurement Main (L*W*H cm)	261 x 173 x 185
Folding (L*W*H cm)	310 x 149 x 220
Winding (L*W*H cm)	229 x 149 x 175

Correct specifications depend on the actual model. All specifications are subject to change without prior notice.

## FEATURES >>

- Uses servo motor for feeding, with stable sealing abilities, and fast on speed change. Easy to change bag size, and size error is permissible.
- This machine is specialized for manufacturing perforated coreless bag-on-roll products. Available for single line "C" folding & double-line regular bag.

# BJAHCL2+ST

Double-Independent-Lane Coreless 'Star' Folding  
Perforating Bag-on-Roll Machine



BJAHCL2+ST



PARKINS PLASTIC MACHINERY CO., LTD.

## SPECIFICATIONS >>

MODEL	BJAHCL +CF 3248
Max. Cutting Width mm (inch)	177 ( 7" ) x 2
Max. Cutting Length m (inch)	1.2 ( 48" )
Thickness (micron / sheet)	6 - 25
Length Tolerance (mm)	±1
Production Rate (pcs / min)	max.200
AC Driving Motor (HP)	2
Heater Capacity (kW)	4.2
Power Required (kW)	19.1
Machine Dimensions (L*W*H cm)	770 x 300 x 190
Machine Weight (kg)	3200
Max Width of Finished Roll Double Line mm (inch)	76 - 177 ( 3" - 7" ) x 2

Correct specifications depend on the actual model. All specifications are subject to change without prior notice.

## FEATURES >>

- Uses servo motor for feeding, with stable sealing abilities, and fast on speed change. Easy to change bag size, and size error is permissible.
- This machine is specialized for manufacturing perforated coreless bag-on-roll products. Available for double line "Star" sealing & regular bag.

# BJAHPCL2+STL

Double-Independent-Lane Coreless 'Star' Folding T-shirt Bag-on-Roll Machine with Labeling Device

## SPECIFICATIONS >>

MODEL	BJAHPCL2+STL 2842
Max. Cutting Width mm (inch)	101- 177 ( 4" - 7" ) x 2
Max. Cutting Length mm (inch)	762 ( 30")
Thickness (micron / sheet)	8 - 25
Length Tolerance (mm)	±1
Production Rate (pcs / min)	max.120
AC Driving Motor (HP)	2
Heater Capacity (kW)	7.6
Power Required (kW)	22.1
Machine Dimensions (L*W*H cm)	960 x 300 x 175
Machine Weight (kg)	5200
Packing Measurement Main (L*W*H cm)	295 x 155 x 198
Folding (L*W*H cm)	310 x 225 x 175
Winding (L*W*H cm)	270 x 220 x 195

Correct specifications depend on the actual model. All specifications are subject to change without prior notice.

## FEATURES >>

- Uses servo motor for feeding, with stable sealing abilities, and fast on speed change. Easy to change bag size, and size error is permissible.
- This machine is specialized for manufacturing perforated coreless bag-on-roll products. Available for double line "Star" sealing T-shirt bag & regular bag.

BJAHPCL2+STL

10

PARKINS PLASTIC MACHINERY CO., LTD.



# BJAHCD

Single-Lane with Core & Coreless Fully Automatic  
Servo-Control Perforating & Winding Bag-on-Roll Machine

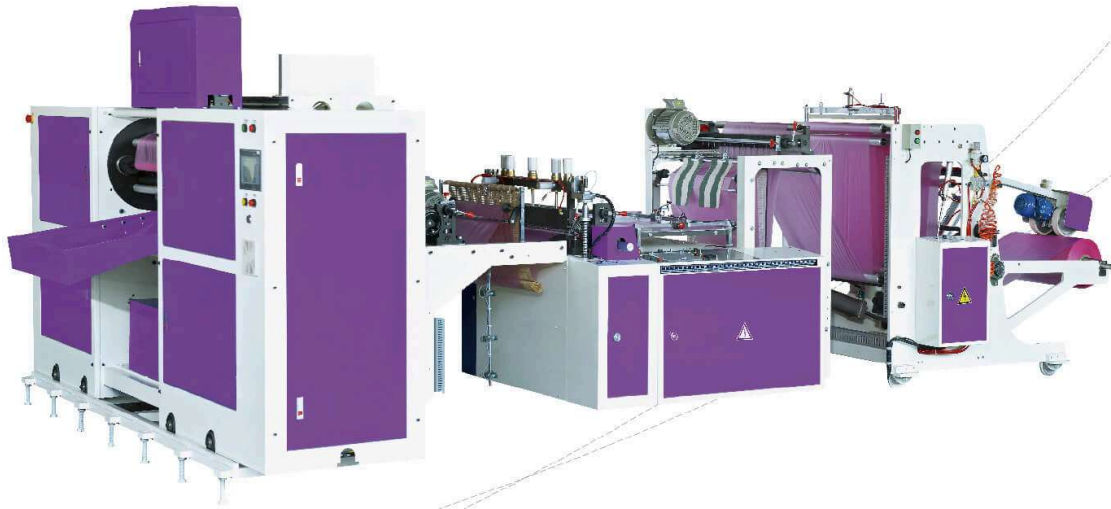

BJAHCD  
PARKINS PLASTIC MACHINERY CO., LTD.

## SPECIFICATIONS >>

MODEL	BJAHCD
Max. Cutting Width mm (inch)	584 (23")
Max. Cutting Length m (inch)	1.2 (48")
Thickness (micron / sheet)	8 - 25
Production Rate Pcs / min	max.200
M / min	max.100
AC Driving Motor (HP)	2
Heater Capacity (kW)	4
Power Required (kW)	14.9
Machine Weight (kg)	4300
Packing Measurement Main (L*W*H cm)	203 x 161 x 185
Folding (L*W*H cm)	330 x 227 x 220
Winding (L*W*H cm)	203 x 150 x 191

Correct specifications depend on the actual model. All specifications are subject to change without prior notice.

## FEATURES >>

- Fully automatic perforated winding device with core and coreless double function.

**OPTION** | **Film Attachment Device** - Function which allows easy attachment of films by heating.  
 Use when changing into new roll of film or when film breakage occurs.

**Bag Attachment Device**

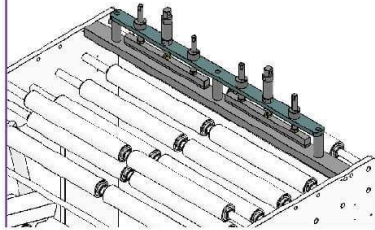

**EPC**

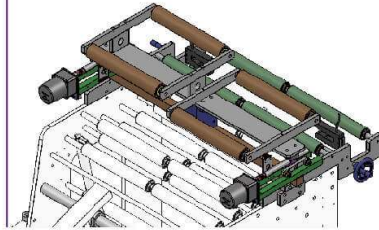

**Cylinder For Film Raise**

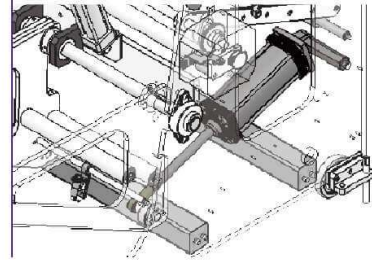

**Air Shaft**

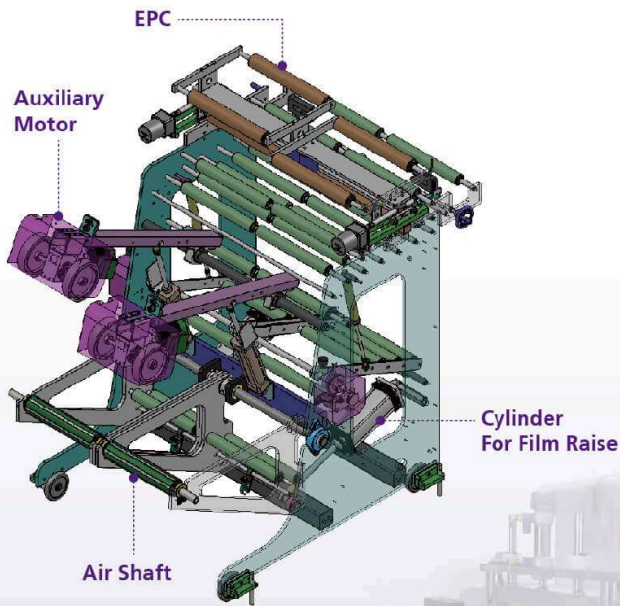
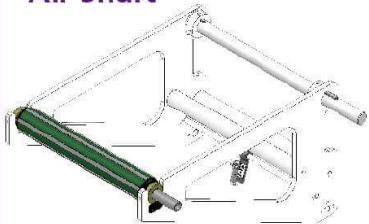

OPTION 12

PARKINS PLASTIC MACHINERY CO., LTD.

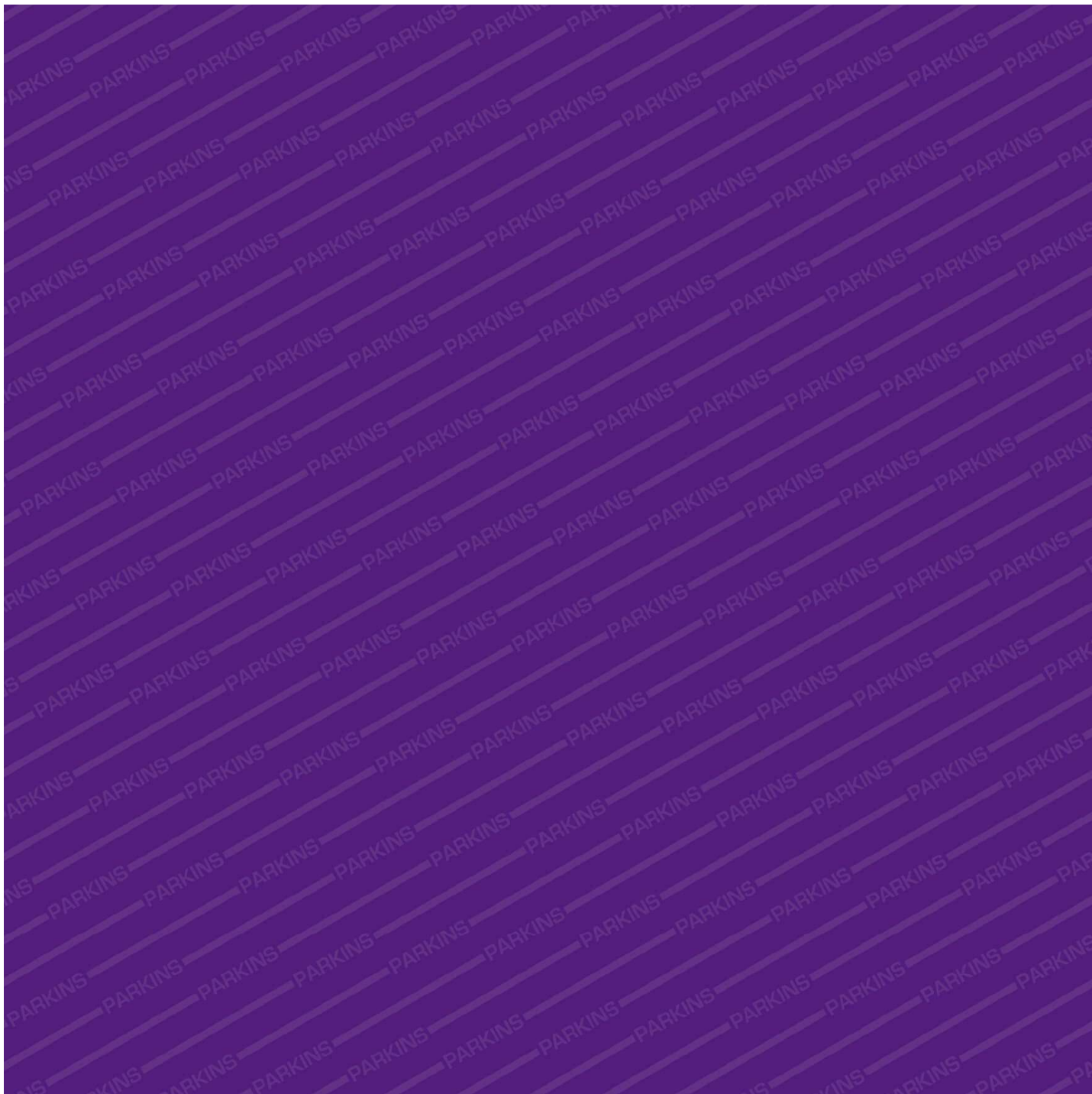



**PARKINS**  
PLASTIC MACHINERY CO.,LTD  
百久塑膠機械有限公司

嘉義縣水上鄉回歸村北回123號

NO.123 Pei Hui, Hui Kuei Village, Shui Shang Township, Chiayi County, Taiwan.

TEL:+886-5-2358505, 2359505, 2356586 FAX:+886-5-2359463

E-mail: pks8989@ms12.hinet.net / bj8899@ms39.hinet.net

<http://www.parkins.com.tw>

